

GENERAL SPARE PARTS FOR MULLER

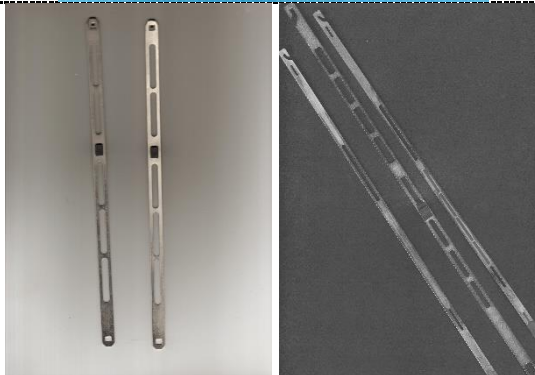

BELT FOR MU2 AND MU3 :

LENGTH	Z Teeth	
1400 mm	100	14
1890 mm	135	14
2100 mm	150	14
2240 mm	160	14
2310 mm	165	14
2380 mm	170	14
2450 mm	175	14
2800 mm	200	14
3150 mm	225	14
4326 mm	309	14
4578 mm	327	14



JACQUARD PLATINE



VARIUS ELECTRONIC BOARD

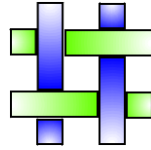

NicTech srl

SPARE PARTS FOR MBJ2



BELT FOR MBJ2



RAPIER RHS AND LHS FOR MBJ2

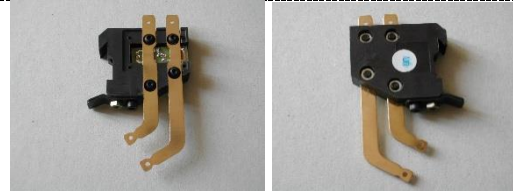

HOT SLIT CUTTER FOR MBJ2

Nictech Srl
Via San Clemente 11
13897 Occhieppo Inferiore –BI- Italia

PI, CF 02335030025
Tel / Fax (0039) 0152593530
Mail info@nictech.it
www.nictech.it

Banca Sella Agenzia di Occhieppo Inferiore
IBAN : IT15 K03268 44610 0538 9121 4890
CIF (BIC) :SELBIT2BXXX

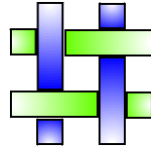

NicTech srl

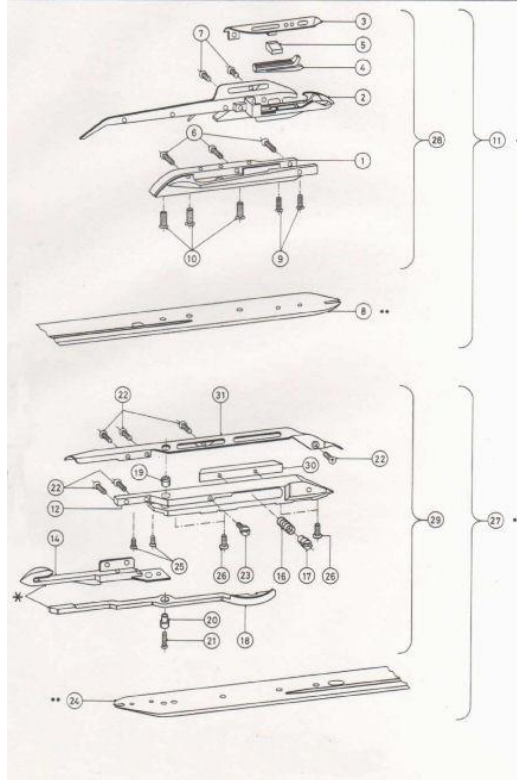

SINGLE PARTS OF GRIPPER MBJ2

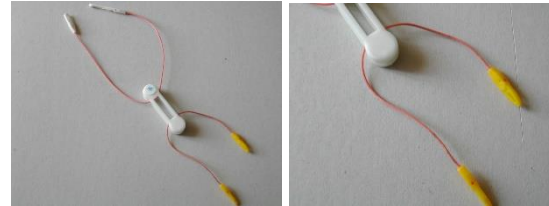

**JACQUARD LOWER BELT MBJ2
JACQUARD UPPER BELT MBJ2
JADE PULLEY MBJ2**



CONNECTION CABLE FOR HOT SLIT CUTTER



Nictech Srl
Via San Clemente 11
13897 Occhieppo Inferiore -BI- Italia

PI, CF 02335030025
Tel / Fax (0039) 0152593530
Mail info@nictech.it
www.nictech.it

Banca Sella Agenzia di Occhieppo Inferiore
IBAN : IT15 K03268 44610 0538 9121 4890
CIF (BIC) :SELBIT2BXXX

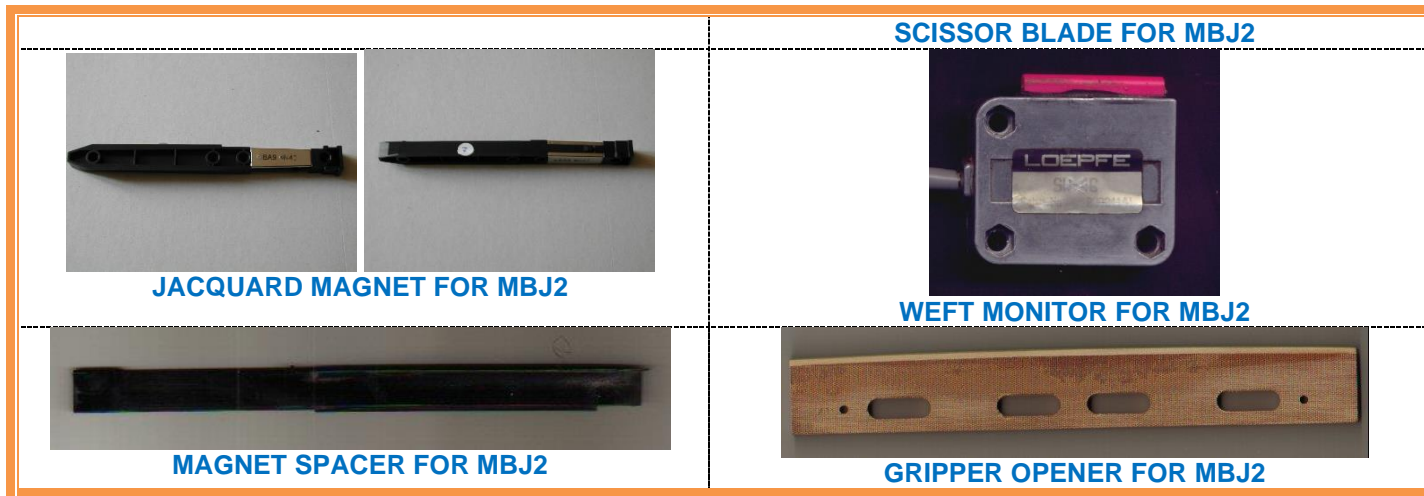

SPARE PARTS FOR MBJ3 AND MBJ3.1

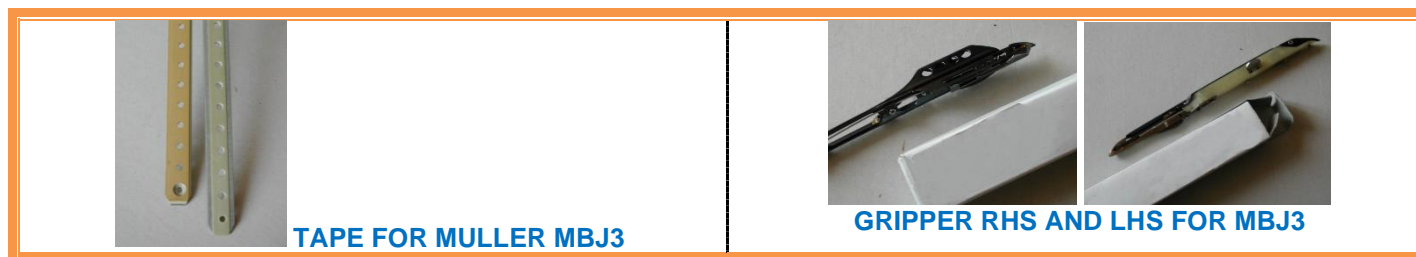

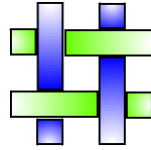

NicTech srl

	
HOT SLIT CUTTER MBJ3	HOT SLIT CUTTER 2 LEGS
	
MBJ3 RHS GRIPPER OPENER	MBJ3 UPPER BELT MBJ3 LOWER BELT MBJ3 JADE PULLEY
	
RAPIER WHEEL	MBJ3 SCISSOR BLADE

Nictech Srl
Via San Clemente 11
13897 Occhieppo Inferiore –BI- Italia

PI, CF 02335030025
Tel / Fax (0039) 0152593530
Mail info@nictech.it
www.nictech.it

Banca Sella Agenzia di Occhieppo Inferiore
IBAN : IT15 K03268 44610 0538 9121 4890
CIF (BIC) :SELBIT2BXXX

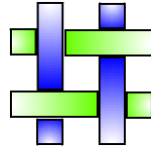

NicTech srl

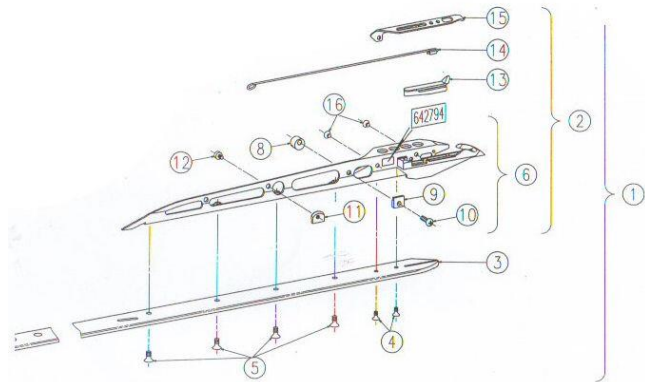

SINGLE PARTS OF MBJ3 GRIPPER LHS

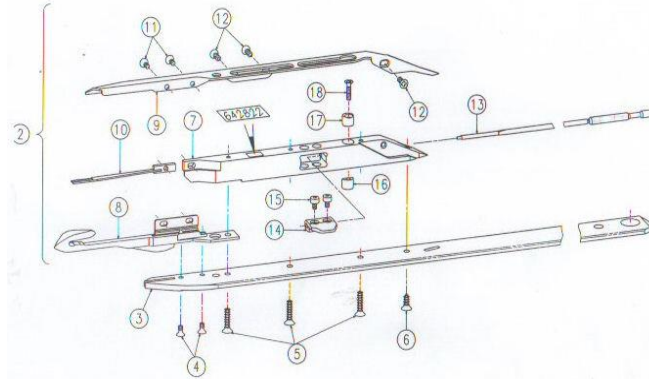

SINGLE PARTS OF MBJ3 GRIPPER RHS



GRIPPER FOR MBJ3.1



GUIDE HOOKS FOR MBJ3 TAPE



**WEFT MONITOR
NO. 179671939
MBJ3 , MBJ3.1**



MAGNET FOR MBJ3

Nictech Srl
Via San Clemente 11
13897 Occhieppo Inferiore -BI- Italia

PI, CF 02335030025
Tel / Fax (0039) 0152593530
Mail info@nictech.it
www.nictech.it

Banca Sella Agenzia di Occhieppo Inferiore
IBAN : IT15 K03268 44610 0538 9121 4890
CIF (BIC) :SELBIT2BXXX

SPARE PARTS FOR NEEDLE LOOMS



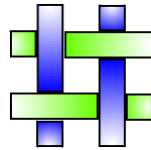

NicTech srl

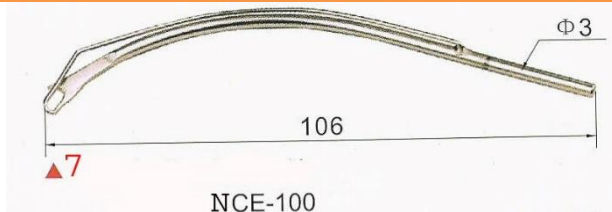

NCE-100
A7 NEEDLE 106 MM DIAM 3 MM



NCE-100
A8 NEEDLE 39 MM DIAM 2,5 MM

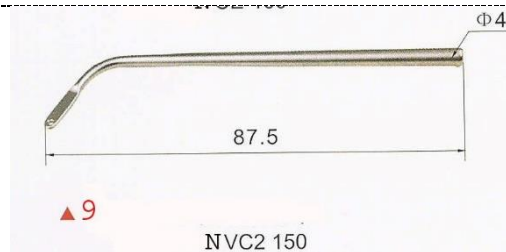

NVC2 150
A9 NEEDLE 87,5 MM DIAM 4 MM

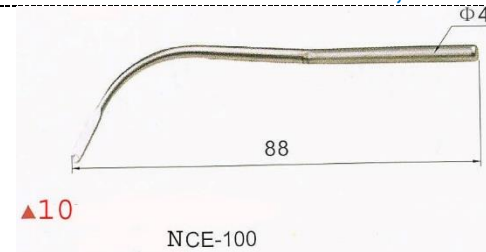

NCE-100
A10 NEEDLE 88 MM DIAM 4 MM



NCE-100
A11 NEEDLE 172,5 MM DIAM 6 MM

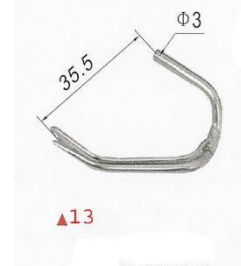

NVC2.1/150
A13 NEEDLE 35,5 MM DIAM 3 MM

Nictech Srl
Via San Clemente 11
13897 Occhieppo Inferiore –BI- Italia

PI, CF 02335030025
Tel / Fax (0039) 0152593530
Mail info@nictech.it
www.nictech.it

Banca Sella Agenzia di Occhieppo Inferiore
IBAN : IT15 K03268 44610 0538 9121 4890
CIF (BIC) :SELBIT2BXXX

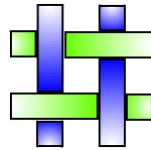

NicTech srl

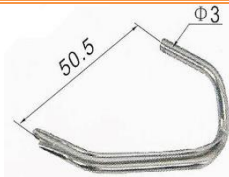

▲14

NVC2.1/150

A14 NEEDLE 50,5 MM DIAM 3 MM

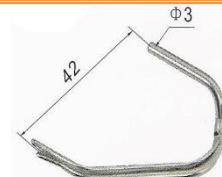

▲15

NVC2.1/150

A15 NEEDLE 42 MM DIAM 3 MM

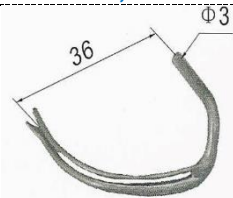

▲16

NVC2.1/150

A16 NEEDLE 36 MM DIAM 3 MM

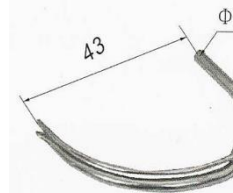

▲17

NVC2 150

A17 NEEDLE 43 MM DIAM 4 MM



▲18

NVC2 150

A18 NEEDLE 50,5 MM DIAM 4 MM



▲19

NVC2 150

A19 NEEDLE 60 MM DIAM 4 MM

Nictech Srl
Via San Clemente 11
13897 Occhieppo Inferiore –BI- Italia

PI, CF 02335030025
Tel / Fax (0039) 0152593530
Mail info@nictech.it
www.nictech.it

Banca Sella Agenzia di Occhieppo Inferiore
IBAN : IT15 K03268 44610 0538 9121 4890
CIF (BIC) :SELBIT2BXXX

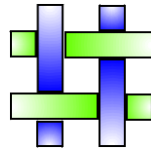

NicTech srl

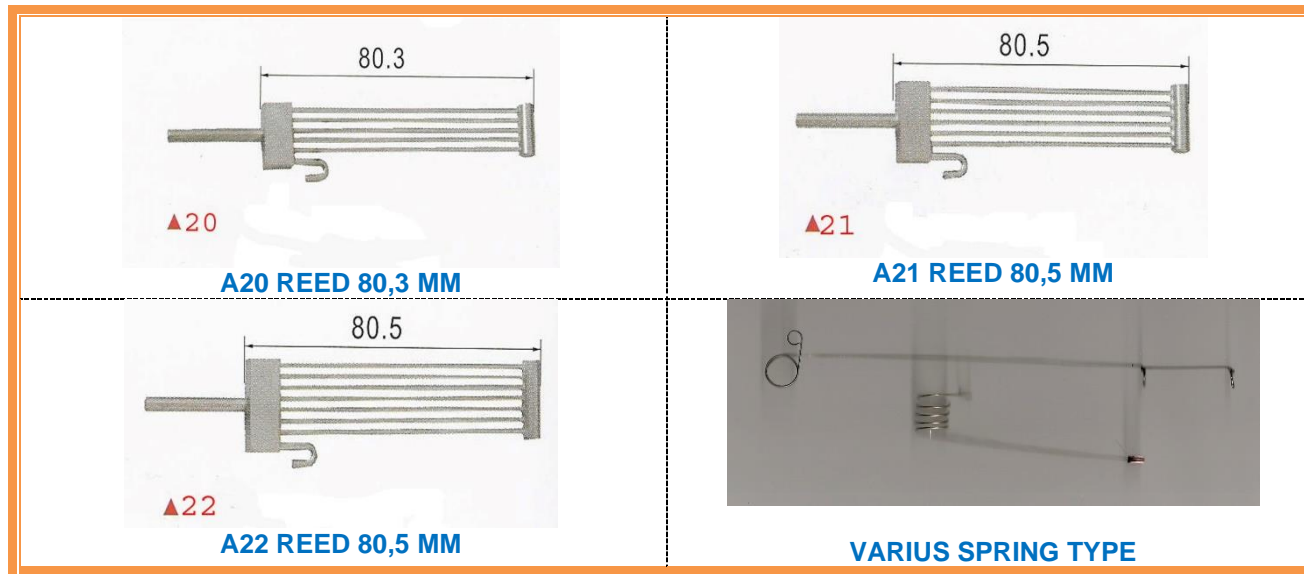

<u>PHOTO</u>	<u>DESCRIPTION</u>	<u>CODE</u>
	<p>ELECTRONIC BOARD FOR MEI SLITTER VERS 01</p>	<p>CL063-1 CL063-2</p>

Nictech Srl
Via San Clemente 11
13897 Occhieppo Inferiore –BI- Italia

PI, CF 02335030025
Tel / Fax (0039) 0152593530
Mail info@nictech.it
www.nictech.it

Banca Sella Agenzia di Occhieppo Inferiore
IBAN : IT15 K03268 44610 0538 9121 4890
CIF (BIC) :SELBIT2BXXX

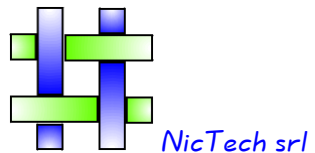

	<p>INTERNAL PART FOR MEI SLITTER BAR</p>	<p>LEIMB</p>
	<p>EXTERNAL MASK FOR MEI SLITTER BAR</p>	<p>COV1MM</p>
	<p>RIVETS FOR MEI SLITTERS</p>	<p>CL088</p>
	<p>VAUPEL MONITOR</p>	
	<p>CUTTING UNIT VAUPEL</p>	<p>86488194-48V-R</p>

Nictech Srl
 Via San Clemente 11
 13897 Occhieppo Inferiore –BI- Italia

PI, CF 02335030025
 Tel / Fax (0039) 0152593530
 Mail info@nictech.it
www.nictech.it

Banca Sella Agenzia di Occhieppo Inferiore
 IBAN : IT15 K03268 44610 0538 9121 4890
 CIF (BIC) :SELBIT2BXXX

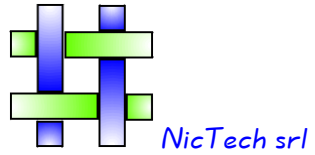

	<p>MASTER CONTROL UNIT VAUPEL</p>	<p>86488190B-R</p>
	<p>ALIMENTATION BOARD VAUPEL</p>	
	<p>INTERFACE BOARD VAUPEL</p>	
	<p>MULLER GREEN BELTS 200 MM</p>	<p>179345755</p>

Nictech Srl
 Via San Clemente 11
 13897 Occhieppo Inferiore –BI- Italia

PI, CF 02335030025
 Tel / Fax (0039) 0152593530
 Mail info@nictech.it
www.nictech.it

Banca Sella Agenzia di Occhieppo Inferiore
 IBAN : IT15 K03268 44610 0538 9121 4890
 CIF (BIC) :SELBIT2BXXX

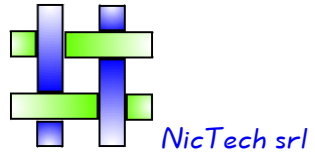

	GREEN BELT 180 MM	179345754
	GREEN BELTS WITH HOOK 260 MM	179345757
	GREEN BELTS 260 MM	179345758
	GREEN BELTS 230 MM	CINGHIEVERDI230
	HOOK FOR BELTS	JA029
	FLAT TEMPLE RINGS FOR MULLER	
	TEMPLE RINGS WITH BOLTS FOR MULLER	

Nictech Srl
Via San Clemente 11
13897 Occhieppo Inferiore –BI- Italia

PI, CF 02335030025
Tel / Fax (0039) 0152593530
Mail info@nictech.it
www.nictech.it

Banca Sella Agenzia di Occhieppo Inferiore
IBAN : IT15 K03268 44610 0538 9121 4890
CIF (BIC) :SELBIT2BXXX

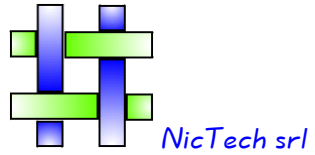

NicTech srl

	PLULLEY FOR FLAT BELTS	179345748
	PULLEY FOR MBJ2	CL021
	PULLEY FOR MBJ3	179345815
	SPE MAGNET PRINT	179729218

Nictech Srl
Via San Clemente 11
13897 Occhieppo Inferiore –BI- Italia

PI, CF 02335030025
Tel / Fax (0039) 0152593530
Mail info@nictech.it
www.nictech.it

Banca Sella Agenzia di Occhieppo Inferiore
IBAN : IT15 K03268 44610 0538 9121 4890
CIF (BIC) :SELBIT2BXXX

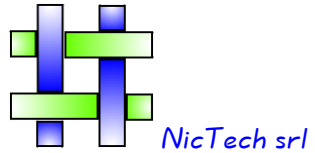

	<p>PRINT AMPLIFIER</p>	<p>179729098</p>
	<p>PLATINE 390 MM</p>	<p>PLATINE390</p>
	<p>PLATINE 360 MM</p>	<p>PLATINE360</p>
	<p>YELLOW PLATINE 310 MM FOR MBJ3</p>	<p>179325468NO</p>
	<p>BLUE PLATINE 310 MM FOR MBJ3</p>	<p>179325419</p>
	<p>BLUE PLATINE 250 MM</p>	<p>PLATINE250</p>
	<p>GREEN PLATINE 250 MM</p>	<p>179325433</p>
	<p>BLUE MAGNET FOR MBJ3</p>	<p>179335592NO</p>

Nictech Srl
 Via San Clemente 11
 13897 Occhieppo Inferiore –BI- Italia

PI, CF 02335030025
 Tel / Fax (0039) 0152593530
 Mail info@nictech.it
www.nictech.it

Banca Sella Agenzia di Occhieppo Inferiore
 IBAN : IT15 K03268 44610 0538 9121 4890
 CIF (BIC) :SELBIT2BXXX

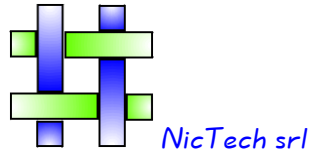

	GREEN MAGNET	179335693NO
	BLACK MAGNET FOR MBJ1 AND 2	179325340NO
	MAGNET SPACER	CL025
	GRIPPER MBJ1-2 LHS	MBJ2LHS
	GRIPPER MBJ1-2 RHS 631366	MBJ2RHS
	GRIPPER MBJ2 RHS	642822
	GRIPPER LHS MBJ3	MBJ3LHS
	GRIPPER RHS MBJ3	MBJ3RHS

Nictech Srl
Via San Clemente 11
13897 Occhieppo Inferiore –BI- Italia

PI, CF 02335030025
Tel / Fax (0039) 0152593530
Mail info@nictech.it
www.nictech.it

Banca Sella Agenzia di Occhieppo Inferiore
IBAN : IT15 K03268 44610 0538 9121 4890
CIF (BIC) :SELBIT2BXXX

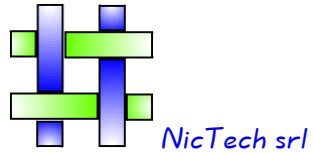

	MBJ3 GRIPPER HEAD RHS	MBJ3RHS
	MBJ3.1 GRIPPER HEAD LHS	MBJ3.1LHS
	MBJ3.1 GRIPPER HEAD RHS	MBJ3.1RHS
	MBJ6 GRIPPER HEAD LHS	179035899
	MUGRIP 3 LHS BELT 1092 mm	N602-1092
	MUGRIP 3 RHS BELT 1077 mm	N601-1077
	MUGRIP 3.1 RHS BELT 1077 mm	N603-1077
	MUGRIP 2 LHS BELT 952 mm	N604-952
	MUGRIP 2 RHS BELT 947 mm	N605-947
		MUGRIP 6 LHS BELT 1321 MM
MUGRIP 6 RHS BELT 1248 MM		N619-1248

Nictech Srl
Via San Clemente 11
13897 Occhieppo Inferiore –BI- Italia

PI, CF 02335030025
Tel / Fax (0039) 0152593530
Mail info@nictech.it
www.nictech.it

Banca Sella Agenzia di Occhieppo Inferiore
IBAN : IT15 K03268 44610 0538 9121 4890
CIF (BIC) :SELBIT2BXXX

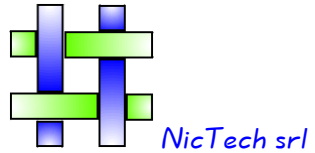

	HOT SLIT WIRE (BOBBIN) 0,22 MM	179013795
	MULLER HOT SLIT CUTTER 10 MM	CL041
	MBJ3 HOT SLITTER LEG SET	MBJLEGSET
	CONNECTION CABLE L=180	JB058
	WEFT FINGER FOR MBJ3 WITH CERAMIC EYE	179335628NO
	RIGHT OPENER MBJ2	179641825

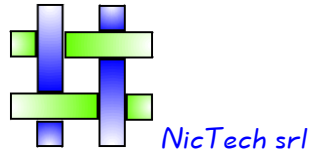





	RIGHT OPENER MBJ3	J3GO
	BACKSET LHS MBJ3	179641662
	SHORT SPRING 0,5 MM	979040063
	LINEAR SPRING 0,50 MM	979040541
	LINEAR SPRING 0,60 MM	97940542
	LINEAR SPRING 0,70 MM	97940543
	DOUBLE EYE SPRING 0,50 MM WITH CERAMIC	179742433C
	SPRING 0,50 MM	979070640
	SPRING 0,6 MM	979070749
	SHORT SPRING WITH CERAMIC	979070219

Nictech Srl
Via San Clemente 11
13897 Occhieppo Inferiore –BI- Italia

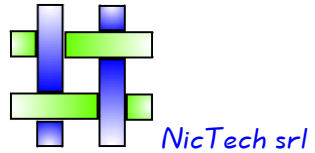
PI, CF 02335030025
Tel / Fax (0039) 0152593530
Mail info@nictech.it
www.nictech.it

Banca Sella Agenzia di Occhieppo Inferiore
IBAN : IT15 K03268 44610 0538 9121 4890
CIF (BIC) :SELBIT2BXXX

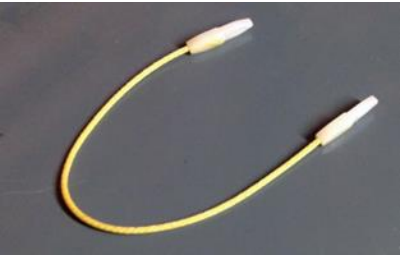

	UPPER PLASTIC CORD 225 MM	179345818
	LOWER PLASTIC CORD WITH HOOK 260 MM	179345819
	UPPER PLASTIC CORD 160 MM	179345972NO
	LOWER PLASTIC CORD WITH HOOK 160 MM	179345973
	CORDS 160 MM	CORDINI160MM

Nictech Srl
Via San Clemente 11
13897 Occhieppo Inferiore –BI- Italia

PI, CF 02335030025
Tel / Fax (0039) 0152593530
Mail info@nictech.it
www.nictech.it

Banca Sella Agenzia di Occhieppo Inferiore
IBAN : IT15 K03268 44610 0538 9121 4890
CIF (BIC) :SELBIT2BXXX

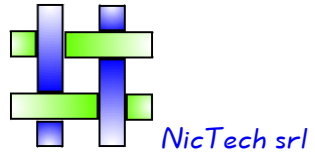

	CORDS 200 MM	CORDINI200MM
	CORDS 225 MM	CORDINI225MM
	CORDS 255 MM WITH HOOK	CORDINI255MM
	CORDS 300 MM WITH HOOK	CORDINI300MM

Nictech Srl
Via San Clemente 11
13897 Occhieppo Inferiore –BI- Italia

PI, CF 02335030025
Tel / Fax (0039) 0152593530
Mail info@nictech.it
www.nictech.it

Banca Sella Agenzia di Occhieppo Inferiore
IBAN : IT15 K03268 44610 0538 9121 4890
CIF (BIC) :SELBIT2BXXX

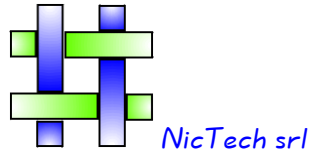

	TOOL HOLDER 292 MM	179335374
	FIBER DISC 22/12,0X0,7	154291087
	DISC 90/70,5X1	054291102
	FELTS 14/5,5x5	054291104
	FIBER SUPPORT	345216
	NEEDLE FOR MCE 53 MM	979030095

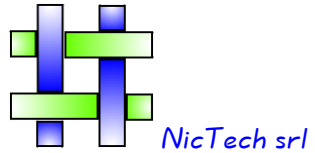

	<p>NEEDLE FOR MCE 70,5 MM</p>	<p>979030092</p>
	<p>NEEDLE MCE 83 MM</p>	<p>979030094</p>
	<p>NEEDLE MCE 87,5 MM</p>	<p>JC004</p>
	<p>NEEDLE</p>	<p>179730826</p>
	<p>NEEDLE A5 58 MM</p>	<p>A5</p>

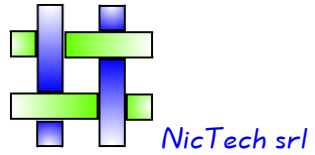

	<p>NEEDLE MVC 39 MM</p>	<p>JC008</p>
	<p>NEEDLE MVC 20X3</p>	<p>979030163</p>
	<p>NEEDLE MVC 25X3</p>	<p>979030164</p>
	<p>NEEDLE MVC 30X3</p>	<p>979030162</p>
	<p>NEEDLE MVC 35X3</p>	<p>JC014</p>
	<p>NEEDLE MVC 40X3</p>	<p>A15</p>

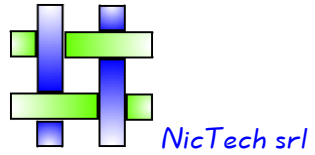

	<p>NEEDLE MVC 46X4</p>	<p>JC017</p>
	<p>NEEDLE MVC 60X4</p>	<p>979030234</p>
	<p>NEEDLE MVC 70X4</p>	<p>979030159</p>
	<p>NEEDLE 165 MM</p>	<p>979030157</p>

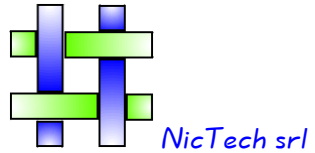

	NEEDLE	179740679NO
	NEEDLE	179731720NO
	REED FOR 4 COLOURS	979030098
	REED FOR 6 COLOURS	979030056
	REED FOR 5 COLOURS	979030055
	REED FOR 8 COLOURS	979030028

Nictech Srl
Via San Clemente 11
13897 Occhieppo Inferiore –BI- Italia

PI, CF 02335030025
Tel / Fax (0039) 0152593530
Mail info@nictech.it
www.nictech.it

Banca Sella Agenzia di Occhieppo Inferiore
IBAN : IT15 K03268 44610 0538 9121 4890
CIF (BIC) :SELBIT2BXXX

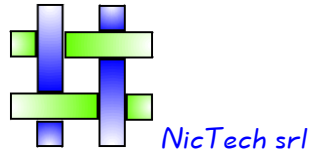

	<p>LEVER</p>	<p>179741298</p>
	<p>SHAFT</p>	<p>333036</p>
	<p>COMPLETE MAGNET PRINT FOR MBJ1 AND 2</p>	<p>N000976NO</p>
	<p>DAMPER PLATE</p>	<p>179315351</p>

Nictech Srl
 Via San Clemente 11
 13897 Occhieppo Inferiore –BI- Italia

PI, CF 02335030025
 Tel / Fax (0039) 0152593530
 Mail info@nictech.it
www.nictech.it

Banca Sella Agenzia di Occhieppo Inferiore
 IBAN : IT15 K03268 44610 0538 9121 4890
 CIF (BIC) :SELBIT2BXXX

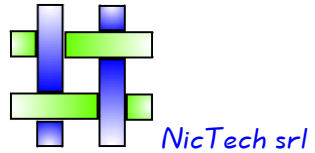

	<p>HOOK</p>	<p>979040599</p>
	<p>WHEEL Z62 FOR MBJ2</p>	<p>979040014</p>
	<p>BELT SYNCHROFLEX L=1400 Z140 AT10 H50</p>	<p>MYPAT10140050</p>

Nictech Srl
 Via San Clemente 11
 13897 Occhieppo Inferiore –BI- Italia

PI, CF 02335030025
 Tel / Fax (0039) 0152593530
 Mail info@nictech.it
www.nictech.it

Banca Sella Agenzia di Occhieppo Inferiore
 IBAN : IT15 K03268 44610 0538 9121 4890
 CIF (BIC) :SELBIT2BXXX

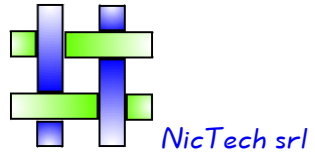

	GROZ BECKERT NEEDLE 86-48	163900135
	MOBILE BLADES FOR SCISSOR MBJ3	179631846NO
	FIX BLADE FOR SCISSOR MBJ3	179631845NO
	MOBILE BLADE FOR SCISSOR MBJ2	179631362NO
	FIX BLADE FOR SCISSOR MBJ2	179631361NO

Nictech Srl
Via San Clemente 11
13897 Occhieppo Inferiore –BI- Italia

PI, CF 02335030025
Tel / Fax (0039) 0152593530
Mail info@nictech.it
www.nictech.it

Banca Sella Agenzia di Occhieppo Inferiore
IBAN : IT15 K03268 44610 0538 9121 4890
CIF (BIC) :SELBIT2BXXX

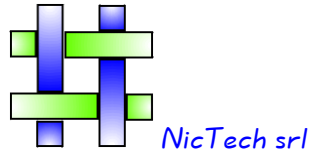

	<p>PRINT BONAS PCB EJ2736/01</p>	<p>75D00299</p>
	<p>TEMPERATUR SENSOR</p>	<p>179651150</p>
	<p>MULOAD KEYBOARD ON LOOM</p>	<p>179339238</p>
	<p>MULOAD KEYBOARD ON LOOM</p>	<p>179739242</p>
	<p>WEFT SELECTOR COMPLETE FOR MBJ2</p>	<p>JB557</p>
	<p>MICROPROCESSOR BOARD 4 MB RAM</p>	<p>179729153</p>

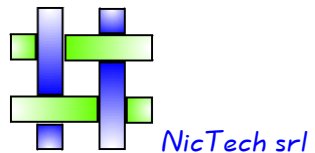

	<p>PRINT CUTTING</p>	<p>179739554</p>
	<p>MBJ3 WEFT SENSOR</p>	<p>179671939</p>
	<p>MBJ2 WEFT SENSOR</p>	<p>641610</p>
	<p>DIGIKAST BOARD</p>	<p>179729338</p>

Nictech Srl
 Via San Clemente 11
 13897 Occhieppo Inferiore –BI- Italia

PI, CF 02335030025
 Tel / Fax (0039) 0152593530
 Mail info@nictech.it
www.nictech.it

Banca Sella Agenzia di Occhieppo Inferiore
 IBAN : IT15 K03268 44610 0538 9121 4890
 CIF (BIC) :SELBIT2BXXX

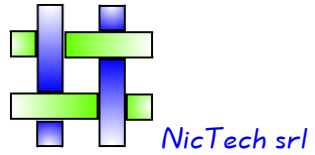

NicTech srl

	<p>KAST 438M</p>	<p>981550049</p>
	<p>WHEEL FOR MBJ1-2</p>	<p>179621031</p>
	<p>WHEEL FOR MBJ3</p>	<p>179621343</p>

Nictech Srl
 Via San Clemente 11
 13897 Occhieppo Inferiore –BI- Italia

PI, CF 02335030025
 Tel / Fax (0039) 0152593530
 Mail info@nictech.it
www.nictech.it

Banca Sella Agenzia di Occhieppo Inferiore
 IBAN : IT15 K03268 44610 0538 9121 4890
 CIF (BIC) :SELBIT2BXXX